

# Resilmount A237R

## Furring channel sound isolation clip

### A237R SPECIFICATIONS

- Width:** 1-3/8"
- Height (including rubber):** 1-1/16"
- Length:** 3-3/16"
- Max spacing between clips:** 48" OC
- Acoustical Design Load:** 37Lbs.
- Thickness added to wall:** 1 5/8"

### SPECIFICATIONS

Code	Clip Height	Metal Thickness	Clip width x length	Height of rubber*
A237R	1 1/16"	0.047"	1 3/8" x 3 3/16"	3/8"

\*Height of rubber on top of clip

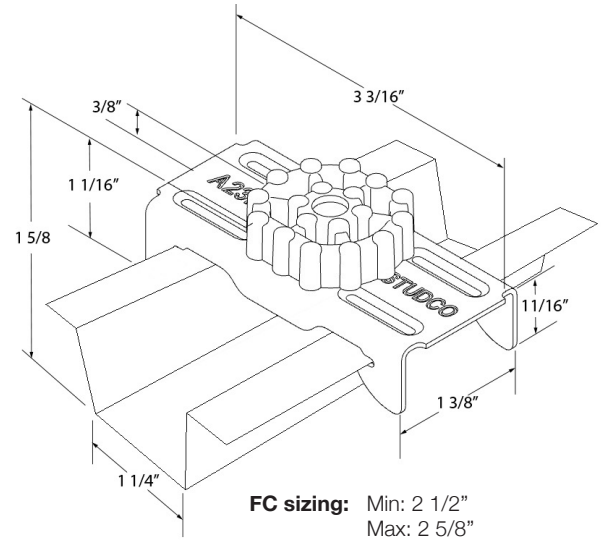

### METAL FURRING CHANNEL SPECIFICATIONS:

- Minimum:** 25 Gauge with hemmed edge
- Depth: Max.** 7/8" or 1 1/2" (15 mil.)
- Width at top:** Max. 1 1/4" (15 mil.)
- Width flange to flange:** Min: 2 1/2" Max: 2 5/8"
- When splicing metal furring channel overlap 6 inches in between two Resilmount clips. Secure the channel with two 7/16" framing screws or 18 Gauge tie wire can be used.
- Splicing:** Furring channel splicing should take place between the clips.

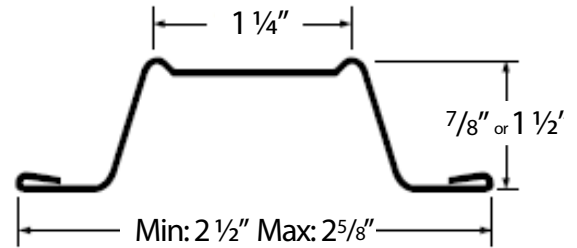

### FASTENERS

- Wood:** # 8 x 2-1/2" Coarse Threads (A)
- Steel:** #8, #10 or #12 x 1-5/8" Self Tapping Type S (B)
- Concrete:** 3/16" x 2-1/4" Anchor Screws (C)
- DO NOT** fasten Resilmount clips to framing members with nails. Use only approved screws.

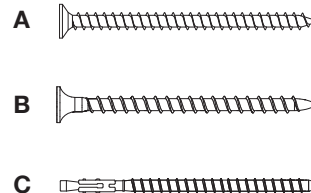

# Resilmount A237R

## Furring channel sound isolation clip

### CEILING INSTALLATION GUIDE

#### INSTALLATION NOTES

- Resilmount A237R shall not exceed 48" on center
- Spacing between metal furring channels shall not exceed 24"
- Fasten the Resilmount A237R to the substrate with a fastener approved for a minimum pull-out and shear of 120 Lbs.
- Locate the first row of A237R within 6 inches of one wall and within 6 inches of the opposite wall
- Metal Furring Channels are installed perpendicular to the joists.
- Install the gypsum board leaving 1/8" - 1/4" thick gap around perimeter to be filled with acoustical caulk.
- Caulk around the entire perimeter of the gypsum board.

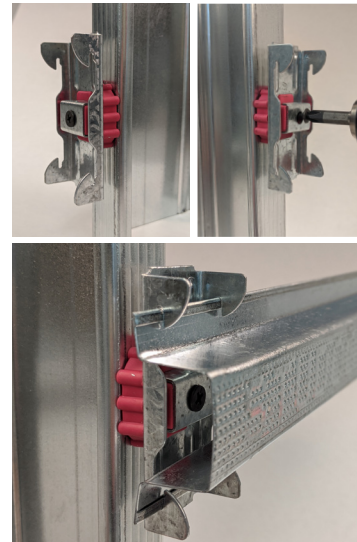

#### CEILING INSTALLATION GUIDE

##### STEP 1

Review layout guidelines before starting installation of walls or ceilings (see Page 4). We suggest installing the ceiling first, before installing the walls.

##### STEP 2

Space Resilmount A237R so not to exceed 48" OC. Secure clips with a single fastener through the middle screw hole in the clip.

Wood: Use #8 x 2-1/2" coarse thread screws

Steel: Use #8, #10, or #12 x 1-5/8" Type s Self tapping screws

Concrete: Use 3/16" x 2-1/4" Tapcon or equal anchor

##### STEP 3

Snap metal furring channel into Resilmount A237R.

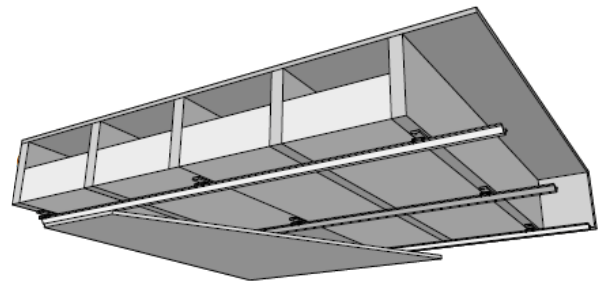

# Resilmount A237R

## Furring channel sound isolation clip

### WALL INSTALLATION GUIDE



#### INSTALLATION NOTES

- Resilmount A237R shall not exceed 48" on center
- Spacing between hat channels shall not exceed 24"
- Fasten the Resilmount A237R to the substrate with a fastener approved for a minimum pull-out and shear of 120 Lbs.
- Locate the bottom row of Resilmount A237R within 3" of the floor. (May be adjusted lower to accommodate installation of baseboard)
- Metal Furring Channels are installed horizontal to the floor.
- Use a level to ensure that Resilmount A237R and furring channels are installed horizontal and level
- Install the drywall vertically from the bottom up leaving a 1/8" - 1/4" thick gap around perimeter of wall to be filled with acoustical caulk. Caulk around the entire perimeter of the gypsum board.

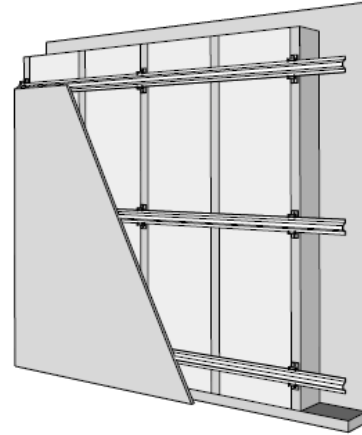

#### WALL INSTALLATION GUIDE

##### Step 1

Review layout guidelines before starting installation of walls or ceilings (see Page 4). We suggest installing the ceiling first, before installing the walls.

##### Step 2

Space Resilmount A237R so not to exceed 48" OC. Secure clips with a single fastener through the middle screw hole in the clip.

Wood: Use #8 x 2-1/2" coarse thread screws

Steel: Use #8, #10, or #12 x 1-5/8" Type s Self tapping screws

Concrete: Use 3/16" x 2-1/4" Tapcon or equal anchor

##### Step 3

Snap metal furring channel into Resilmount A237R.

##### Step 4

The Floor Shims are critical to ensure best results. Place 1/4" shims on floor in front of sole plate. Install the first row of drywall vertically against the wall. Attach drywall to channel following local building codes.

Note: Only remove the shims after all the gypsum board is completely screwed to all furring channels.

##### Step 5

Use acoustical caulk around the entire perimeter of each wall.

#### Average Labor rates

**A237R:** 72 clips per man hour

**Furring channel:** 550 LF per man hour



#### LOAD SPECIFICATION FOR A237R

Resilmount Clips are designed to carry furring channel with one or more layers of gypsum wallboard attached. The load capacity of the clips depends on the gauge of the hat channel used.

25 Gauge furring channel carries less load than 20 Gauge channel and performs better acoustically. The maximum design load capacity for the Resilmount Clips in shear (Wall Application) or in tension (Ceiling Applications) as follows. Design load calculations are based on testing loading to failure where the furring channel deforms.

Maximum Load for Wall and Ceiling	2:1 Safety Factor	2.5:1 Safety Factor*
Resilmount Clips w/25 gauge hat channel	45 lbs	36 lbs
Resilmount Clips w/20 gauge hat channel	60 lbs	48 lbs

\*Suggested safety factor of 2.5:1 for more critical life safety applications.

Note: 5/8" thick gypsum wallboard weighs 2.2 lbs/sq ft.  
 1/2" thick gypsum wallboard weighs 1.6 lbs/sq ft.

# Resilmount A237R

## Furring channel sound isolation clip



### LAYOUTS ON WOOD AND METAL STUD WALLS & CEILINGS

**24" FC:** (sqft) x 0.6 = Furring Channel Lineal Footage / 16" OC is @ (x 0.8)

**A237R:** (Sqft) ÷ 4.5 = Average Qty of Clips needed (24 x 48)

### Layouts for studs at 24" OC with 1 or 2 layers of Gypsum Board

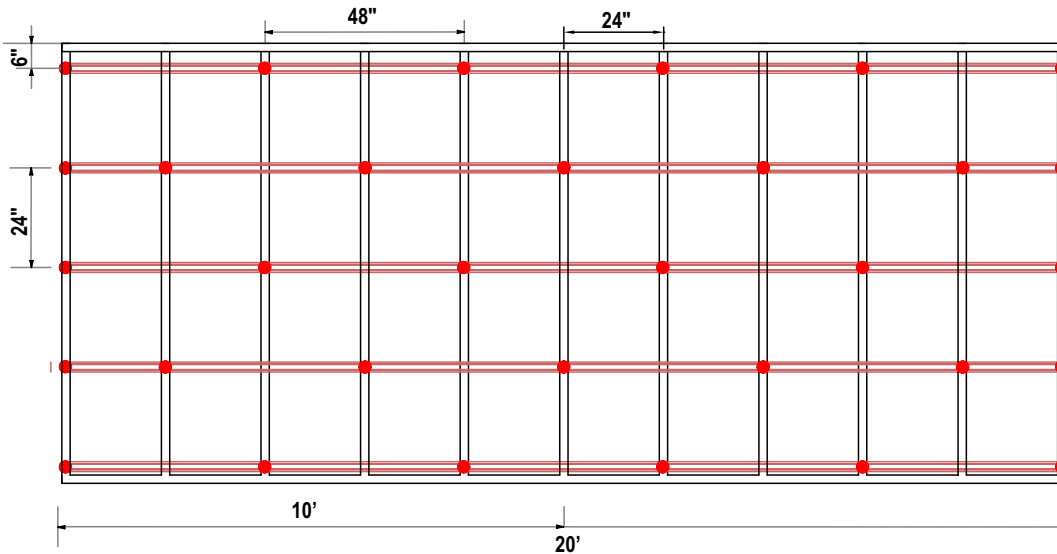

### Layouts for studs at 16" OC with 1 or 2 layers of Gypsum Board

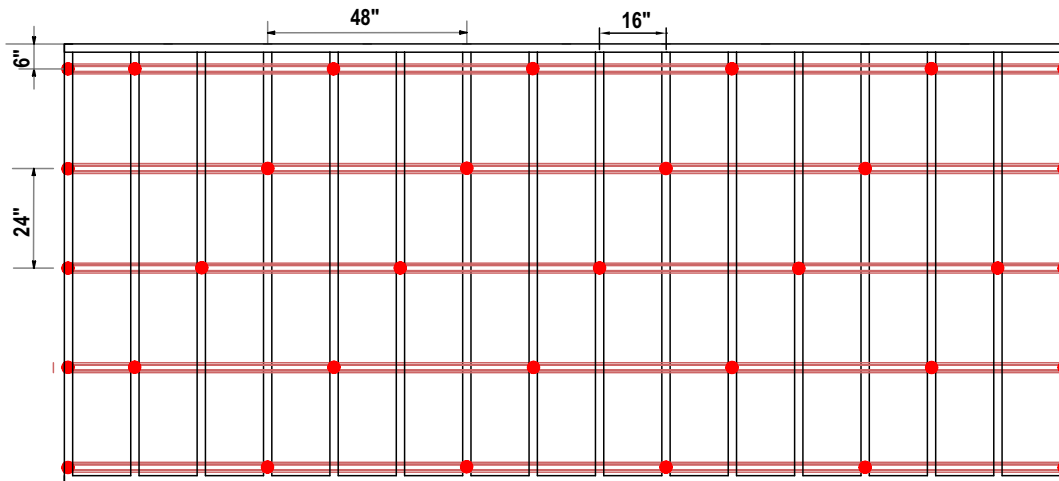

This document is subject to change without notice - please check with Resilmount regarding latest version prior to using. This document is subject to Studco's published terms and conditions.

# Resilmount A237R

## Furring channel sound isolation clip

### CLIP USAGE GUIDE FOR WALLS & CEILINGS

#### Studs at 16" OC and Furring Channel at 24" OC.

##### WIDTH

	1' to 4'	5' to 8'	9' to 12'	13' to 16'	17' to 20'	21' to 24'	25' to 28'	29' to 32'	33' to 36'	37' to 40'
<b>1' to 2'</b>	4	6	8	10	12	14	16	18	20	22
<b>3' to 4'</b>	6	11	14	17	20	23	26	29	32	35
<b>5' to 6'</b>	8	14	18	22	26	30	34	38	42	46
<b>7' to 8'</b>	10	18	23	28	33	38	43	48	53	58
<b>9' to 10'</b>	12	22	28	34	40	46	52	58	64	70
<b>11' to 12'</b>	14	25	32	39	46	53	60	67	74	81
<b>13' to 14'</b>	16	29	37	45	53	61	69	77	85	93
<b>15' to 16'</b>	18	33	42	51	60	69	78	87	96	105
<b>17' to 18'</b>	20	36	46	56	66	76	86	96	106	116
<b>19' to 20'</b>	22	40	51	62	73	84	95	106	117	128
<b>21' to 22'</b>	24	44	56	68	80	92	104	116	128	140
<b>23' to 24'</b>	26	47	60	73	86	99	112	125	138	151
<b>25' to 26'</b>	28	51	65	79	93	107	121	135	149	163
<b>27' to 28'</b>	30	55	70	85	100	115	130	145	160	175
<b>29' to 30'</b>	32	58	74	90	106	122	138	154	170	186
<b>31' to 32'</b>	34	62	79	96	113	130	147	164	181	198
<b>33' to 34'</b>	36	66	84	102	120	138	156	174	192	210
<b>35' to 36'</b>	38	69	88	107	126	145	164	183	202	221
<b>37' to 38'</b>	40	73	93	113	133	153	173	193	213	233
<b>39' to 40'</b>	42	77	98	119	140	161	182	203	224	245

#### Studs at 24" OC and Furring Channel at 24" OC.

##### WIDTH

	1' to 4'	5' to 8'	9' to 12'	13' to 16'	17' to 20'	21' to 24'	25' to 28'	29' to 32'	33' to 36'	37' to 40'
<b>1' to 2'</b>	4	7	9	11	13	15	17	19	21	23
<b>3' to 4'</b>	6	10	13	16	19	22	25	28	31	34
<b>5' to 6'</b>	8	14	18	22	26	30	34	38	42	46
<b>7' to 8'</b>	10	17	22	27	32	37	42	47	52	57
<b>9' to 10'</b>	12	21	27	33	39	45	51	57	63	69
<b>11' to 12'</b>	14	24	31	38	45	52	59	66	73	80
<b>13' to 14'</b>	16	28	36	44	52	60	68	76	84	92
<b>15' to 16'</b>	18	31	40	49	58	67	76	84	93	102
<b>17' to 18'</b>	20	35	45	55	65	75	85	95	105	115
<b>19' to 20'</b>	22	38	49	60	71	82	93	104	115	126
<b>21' to 22'</b>	24	42	54	66	78	90	102	114	126	138
<b>23' to 24'</b>	26	45	58	71	84	97	110	123	136	149
<b>25' to 26'</b>	28	49	63	77	91	105	119	133	147	161
<b>27' to 28'</b>	30	52	67	82	97	112	127	142	157	172
<b>29' to 30'</b>	32	56	72	88	104	120	136	152	168	184
<b>31' to 32'</b>	34	59	76	93	110	127	144	161	178	195
<b>33' to 34'</b>	36	63	81	99	117	135	153	171	189	207
<b>35' to 36'</b>	38	66	85	104	123	142	161	180	199	218
<b>37' to 38'</b>	40	70	90	110	130	150	170	190	210	230
<b>39' to 40'</b>	42	73	94	115	136	157	178	199	220	241

This document is subject to change without notice - please check with Resilmount regarding latest version prior to using. This document is subject to Studco's published terms and conditions.

**For Technical Support and Sales Enquiries, please contact Studco Building Systems 800.675.8023**